

Revolutionary Products for
Film & Video



Multiverse® Transmitter
Studio



CITY THEATRICAL
NEW YORK • LONDON

Made in USA

Multiverse Studio: Next Gen Wireless DMX/RDM for Film & Video

After 20 years of pioneering wireless DMX and RDM for entertainment and architectural lighting, City Theatrical has developed its revolutionary **Multiverse® wireless DMX/RDM** system broadcasting as many as 10 universes of DMX/RDM data from a single transmitter, with the ability to use less radio energy than present-day single universe systems.

Multiverse marks our fifth generation of engineering development.

All previous wireless DMX control systems have suffered from a basic limitation: they are only able to transmit and receive a few universes of DMX data before their radio energy overpowers the spectrum and prevents their signals, and the signals of other devices in the venue, from accomplishing their mission. With this constraint, large scale multiple universe wireless systems simply have not been possible to achieve. In addition, the broadcast spectrum in which DMX systems operate has become overcrowded with other radio signals causing additional interference issues.

Faced with these challenges, we began to plan a new system of wireless lighting control that could be scaled up to unprecedented levels without overpowering the spectrum. Our mission therefore was to be able to deliver more data using less radio energy.



Solution: Multiverse Module

We achieved our goal with the creation of our Multiverse Module. Every product in the Multiverse wireless DMX system is built around these tiny circuit board mounted devices, as an embodiment of this breakthrough technology.



Key Multiverse Features and Benefits for Film & Video projects:

Flexibility & Scalability

Multiverse components can be set up as single or multiple universe configurations. Using our plug and play Multiverse SHoW Baby® or Multiverse Nodes, single universe systems can be created quickly and easily. Using a single Multiverse Transmitter, you can create a system of up to 10 universes.

Ease of Use

Components are easily set up and users can configure their system (depending on model) by its onboard user interface, by RDM, or with City Theatrical's USB Configurator Program, and then control its fixtures using DMX, Streaming ACN, or Art-Net (again depending on model).

Two 2.4GHz Radio Operation

2.4GHz operation is usable worldwide, and for the first time, Multiverse users can broadcast as many of 10 universes of wireless DMX/RDM on two radios in the 2.4GHz band at the same time.

PoE (Power over Ethernet)

Power the Multiverse Transmitter and receive sACN at the same time, without a power cord or external DC adaptor.

Backwards Compatibility

Multiverse SHoW Baby and Multiverse Node can be used seamlessly with highly popular legacy wireless DMX products, including SHoW DMX SHoW Baby® and SHoW DMX Neo®.

RadioScan® Spectrum Analyser

RadioScan can help improve all Multiverse broadcasts by helping the user select the optimum area in the spectrum to place their broadcast. RadioScan coordinates with Multiverse to help select SHoW IDs.

DMXcat® Multi Function Test Tool

The multi award-winning DMXcat makes it easy for anyone to troubleshoot wireless DMX/RDM systems and to control, analyze, or test any DMX lighting fixture, whether it's a simple LED PAR or a complex moving light.

Multiverse technology is covered by U.S. Patents #7,432,803 B2, #10,129,964 B1, and other patents pending.



**More Data Using
Less Radio Energy**

A close-up photograph of a network switch port. A fiber optic cable is plugged into the port, with its multi-colored core visible. A black antenna is attached to the side of the port. The background is a blurred orange wall. A semi-transparent black box is overlaid on the center of the image, containing white text.

Wireless DMX/ RDM

Multiverse® Studio Receiver (P/N 5905)



The **Multiverse® Studio Receiver 2.4GHz** brings the advanced features of the Multiverse wireless DMX/RDM system to the film and video world, where fast setup and reliability are key objectives. The Multiverse Studio Receiver contains a long-life lithium-ion polymer battery giving 20 hours of use. The weather resistant Multiverse Studio Receiver has a full four button user interface with a backlit LCD display that makes setup easy and gives feedback on system performance. Its case is IP61 rated plastic, making it splashproof and rainproof (but not for permanent outdoor use).

The 5905 Multiverse Studio 2.4GHz contains a 2.4GHz radio, which allows the user to select which single universe to receive, and which radio band to use via the Multiverse SHoW ID.

The DMX corded connector allows the Multiverse Studio Receiver's external antenna to hang below the lighting fixture, giving improved data fidelity.



SPECIFICATIONS:

P/N	Frequency	Universes
5905	2.4GHz	1

Physical		
Length	95.25mm	(3.75 in)
Length with Antenna	139.7mm	(5.5 in)
Width	46.0mm	(1.812 in)
Height	25.4mm	(1.0 in)
Antenna	2.4GHz 3.8dBi	
User Interface	4 Button/Backlit LCD display	
Construction	ABS plastic	

Electrical	
Power	Internal battery; included external power supply 100-240VAC input, 5VDC output
Battery	Internal lithium-ion polymer, 20-hour life on default operating settings
Charge time	- Contactless charger: 3.5 hours - USB-C: 2.5 hours

Radio Technology	
Latency	4 ms average
RF Sensitivity	-95dBm
Loss of Data Behavior	Output stops
Broadcast Power	3.2mW, 10mW, 32mW, 100mW EIRP
Broadcast Modes	Adaptive, Full, Low, Mid, High, Max
SHoW IDs	Multiverse: 217; Neo: 70
RDM Features	RDM Proxy, RDM Responder

Product Information	
Use Environment	Indoor, Outdoor (splashproof, not for permanent outdoor use)
IP Rating	IP61
Compliance	FCC, IC, CE, UKCA, ARIB, RoHS
Warranty	One year

Multiverse® Studio Kit
(P/N 5939)



The **Multiverse® Studio Kit 2.4GHz** brings the advanced technology of Multiverse wireless DMX/RDM system to the film and video world, featuring Receivers with 20 hour battery life and contactless charging in an easy to use kit. The Multiverse Studio Kit includes: six battery powered Multiverse Studio Receivers, one Multiverse Transmitter with hanging bracket and clamp (for multi universe broadcasts), one Multiverse Node with hanging bracket and clamp (for single universe broadcasts), one DMXcat Multi Function Test Tool (to turn on and troubleshoot any lighting fixture on set), one RadioScan Spectrum Analyzer (for broadcast planning), and various accessories to keep your equipment organised and charged. The Multiverse Studio Kit provides all the tools lighting technicians need to quickly plan, setup, and operate wireless DMX/RDM on set.



Multiverse Studio Receivers charging in the Multiverse Studio Kit.

SPECIFICATIONS:

P/N	Frequency	Universes
5939	2.4GHz	1 - 10

Product Information	
IP Rating	IP20
Compliance	FCC, IC, cETLus Listed, CE, RoHS
Warranty	One year

KIT INCLUDES:

P/N	Product	Quantity
5905	Multiverse Studio Receiver, 2.4GHz	6
5911	Multiverse Transmitter, 2.4GHz (for multi universe broadcasts)	1
5903	Multiverse Node, 2.4GHz (for single universe broadcasts)	1
6000	DMXcat® Multi Function Test Tool	1
5988	RadioScan™ Spectrum Analyzer	1
5987	USB-A to USB-A cable, 1m	6
5840	Power cord, PowerCON True 1, 8' long	2
5932	Mounting clamp	2
5976	Pelican case with contactless charging	1
n/a	USB flash drive with product manuals and other information	1



Multiverse® Studio Add On Kit (P/N 5941)



The **Multiverse® Studio Add On Kit 2.4GHz (P/N 5941)** brings the advanced technology of the Multiverse wireless DMX/RDM system to the film and video world, featuring Receivers with 20 hour battery life and contactless charging in an easy to use kit.

Just drop the Multiverse Studio Receiver onto its slot in the case, and it will begin charging. Individual chargers and USB cables are also included to enable charging or powering individual units outside the case.

The Multiverse Studio Kit provides six additional Multiverse Studio Receivers for users to expand upon their full 5939 Multiverse Studio Kits.



Multiverse Studio Kit, 2.4GHz (P/N 5939, left) and the Multiverse Studio Add On Kit, 2.4GHz (P/N 5941, right).

SPECIFICATIONS:

P/N	Frequency	Universes
5941	2.4GHz	1 - 10

Product Information

IP Rating	IP20
Compliance	FCC, IC, cELTus Listed, CE, RoHS
Operating Temperature	0° to 40°C when charging
Warranty	One year

KIT INCLUDES:

P/N	Product	Quantity
5905	Multiverse Studio Receivers, 2.4GHz	6
5987	USB-A to USB-C cable, 1m	6
5840	Power Cord, PowerCON True 1, 8' long	1
5977	Pelican case with contactless charging	1
N/A	USB flash drive with product manuals and other information	1





Test Tools

DMX
DMX Tester

Fixture Controller

DIP
DipSwitch Calculator

RDM Controller

RF
RF Analyzer

i
DMXcat® Info

to DMXcat_18

RadioScan® Spectrum Analyser (P/N 5988)

RadioScan®



SPECIFICATIONS:

Physical	
Frequency	2.4-2.483GHz
Length / Width	50 mm (2.0 in)
Length with Antenna Fully Extended	188.9 mm (7.437 in)
Depth	13 mm (0.5 in)
Antenna	Detachable external omni-directional broadband, 2dBi 900MHz, 4dBi 2.4GHz
Construction	NEMA 4 IP20 ABS Plastic
Power/Data Connector	USB-C with 1m (39.37") USB-A to USB-C cable

RadioScan® Spectrum Analyzer (P/N 5988) is a 2.4GHz spectrum analyzer (includes a RadioScan hardware dongle and accompanying free RadioScan software) that enables you to easily visualise radio energy that is otherwise invisible to you. Using RadioScan helps you to create a broadcast plan that optimises available spectrum in your area, and helps prevent interference with other mission critical radio devices near you.

RadioScan shows all radio activity near you in your chosen frequency, including frequency hopping gear like wireless DMX, as well as Wi-Fi networks, Bluetooth, wireless headsets, video transmitters, cordless phones, baby monitors, and microwave ovens. RadioScan can view spectrum data either in Spectrogram view or Waterfall view, notes can be added, and snapshots can be taken and saved. Scans of any length can be recorded, saved, and emailed, and can be played back and reviewed by others with just the free RadioScan software, without the need for the RadioScan hardware dongle.

By identifying SSIDs, broadcast channel, and the signal strength of wireless networks, RadioScan can help IT departments setup, maintain, and troubleshoot their wireless installations.

For users of City Theatrical [Multiverse® wireless DMX/RDM](#) products, RadioScan will guide you in creating the optimum broadcast plan for your production.



RadioScan is compatible with both PC and MAC. RadioScan software is available as a free download at: citytheatrical.com/products/radioscan

(Scroll down to the Downloads tab.)



Shown smaller than actual size.

SPECIFICATIONS: (Continued)

Computer Requirements

Operating System	Windows 10 / Mac OS 10.15 or higher
Display Resolution	800x600
Wi-Fi Radio	Internal or USB Wi-Fi adaptor
USB Port	1.1 or better
RAM	4GB

Product Information

Configuration	City Theatrical RadioScan software program
Use Environment	Indoor
Warranty	One year
Manufacturing Origin	USA
Compliance	FCC, IC, CE, RoHS

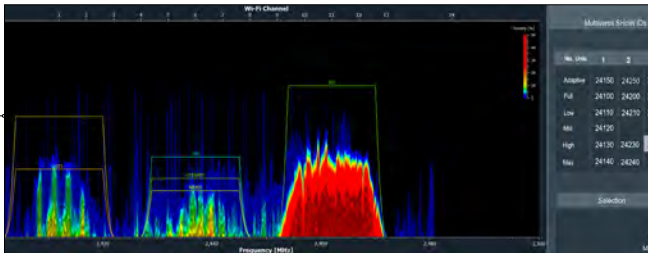

Multiverse SHoW ID Selector

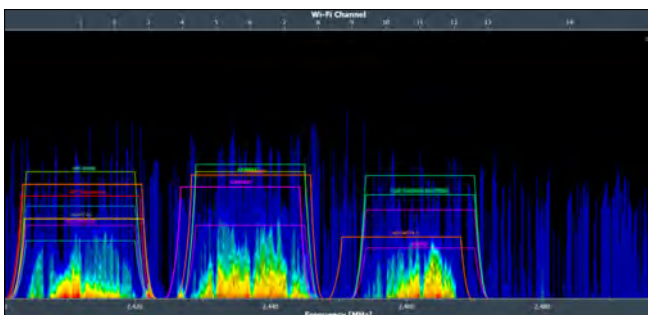

Identify SSID and Signal Strength of
Wi-Fi Networks

View Options:

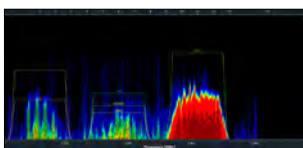

Spectrogram

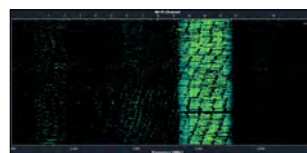

Waterfall

FEATURES:

- Finds all radio activity nearby in chosen spectrum
- Identifies SSID and signal strength of Wi-Fi networks
- Shows either Spectrogram or Waterfall view
- Can record and play back scans of unlimited length
- Takes and saves snapshots
- Records text notes on scans
- Prompts Multiverse SHoW IDs
- Compatible with PC and Mac computers (USB to USB-C cable provided)
- Designed and built in the USA by City Theatrical

DMXcat® Multi Function Test Tool (P/N 6000)

DMXcat®
CONTROL ANALYZE TEST



City Theatrical's multi award-winning DMXcat® makes it easy for anyone to control, analyze, or test any DMX lighting fixture, whether it's a simple LED PAR or a complex moving light. DMXcat consists of a small hardware dongle and a suite of mobile applications. Together, they combine to bring wireless DMX and RDM control plus several other useful functions to the user's smartphone. DMXcat solves the problem faced by all users of modern lighting equipment: How to turn on an test DMX lighting gear without using a complicated lighting console. DMXcat works with Android, iPhone, and Amazon Fire.

Hardware

DMXcat's interface device is a compact battery powered unit that fits easily in a pocket or tool pouch or may be worn on a belt. It uses Bluetooth LE technology for communication with the smartphone/applications (up to 50' range). Without being physically connected, the user can move about the workspace and operate the various apps while still using the phone for on-the-job communication. The device's five pin XLRF connector/cable assembly allows it to be connected to any point in a DMX data chain to allow testing and or control of the various DMX/RDM slot functions. It is charged using a standard USB to Micro-USB cable and charger.

Other features include a built-in LED flashlight, an audible alarm (for locating a misplaced unit), an LED Status indicator, an XLR5M to XLR5M Turnaround, and a removable belt clip. Optional accessories include: XLR5M to RJ45 Adapter, XLR5M to XLR3F Adapter, XLR5M to XLR3M Turnaround, and Belt Pouch.

Software Applications

The DMXcat app, which includes eight modules - DMX Controller, Fixture Controller, DMX Tester, RDM Controller, DIP Switch Calculator, Light Metre (Android only), RF Spectrum Analyser (Android only), and



Multiverse Transmitter (shown only when connected to a Multiverse Transmitter) - is available through Google Play for Android, the App Store for iPhone, and Amazon.co.uk for Amazon Fire.



DMXcat is available in seven languages: Spanish, French, German, Italian, Korean, Japanese, and English, depending on your mobile phone's native language setting.

SPECIFICATIONS:

Part Number	6000
Wireless Communication	Bluetooth LE
Range	50' (15m)
Status LED Indicator	Yes, multicolour
Flashlight	White LED
Charging port	Micro USB
DMX connection	XLR5F
Battery Run Time	20 hours
Charge Time	8 hours
Apps	8 on Android and 6 on iOS, as follows: DMX Controller, Fixture Controller, DIP Switch Calculator, DMX Tester, RDM Controller, Multiverse Transmitter (shown only when connected to Multiverse Transmitter), Light Metre (Android only), RF Spectrum Analyser (Android only)
Construction	NEMA 1 ABS enclosure
Compliance	CE, RoHS, FCC
Weight	0.14 kg (0.3 lbs)
Dimensions (L x W x H)	95.3mm (3.75") x 41.4mm (1.63") x 23.9mm (0.94")

DMXcat is covered by U.S. Patent # 10,129,964 and other U.S and foreign patents pending.

The image shows three parallel strips of LED tape lights against a dark background. The strips are illuminated, showing individual yellowish-white LEDs. The middle strip is the most prominent and has a black rectangular overlay with white text. On this strip, the brand name 'QolorFLEX' is visible, along with 'CITY THEATRICAL IN', 'E15', '+24V', and 'C LISTED US Intertek 9801635'. The other two strips also show similar branding and components like resistors labeled '151'.

LED Tape and Dimmers

QolorFLEX® 5-in-1 LED Tape

RGBACW:	5050-24-RGBACW-60-5-20-1
HiQ High CRI:	5050-24-RGBH27006500-60-5-20-1

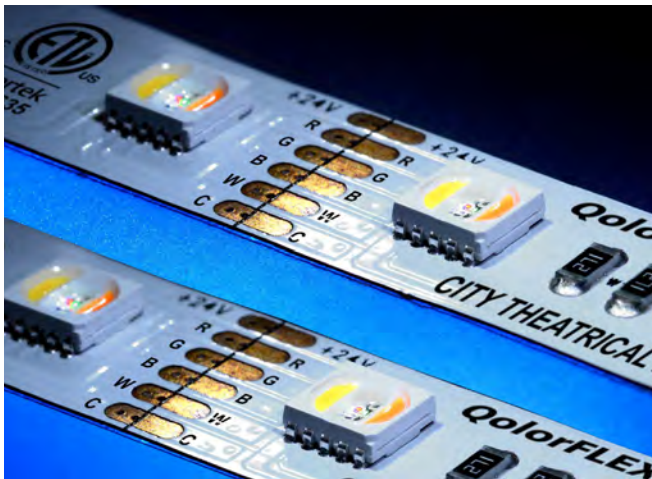

QolorFLEX 5-in-1 LED Tapes are interior grade 5-in-1 24V LED Tapes with high output brightness that provide lighting professionals with ultimate five-colour control, with their ability to create a wide spectrum of colours when used with a DMX colour control system. Each tape comes with wiring leads on both ends and durable 3M adhesive backing. These LED tapes are available in full five meter reels and sample strips. New **QolorFLEX 5-in-1 HiQ High CRI LED Tape** (P/N 5050-24-RGBH27006500-60-5-20-1) has a Colour Rendering Index (CRI) of 95 and is 25% brighter than other 5-in-1 LED tapes, for exceptional on-camera colour rendition and the ability to match the light sources already being used on set for film and video projects.

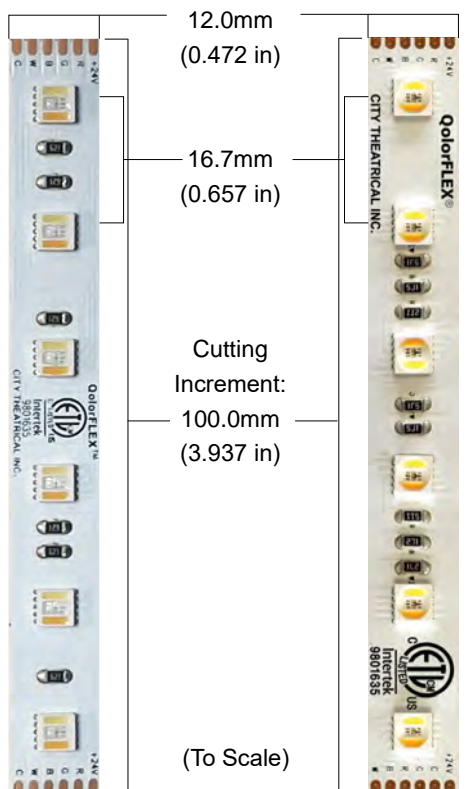

HiQ High CRI

RGB+A+CW

SPECIFICATIONS:

Physical

Length	5m	(16.404 ft)
Width	12mm	(0.472 in)
Cutting Increment	100mm	(3.937 in)
LED Spacing	16.7mm	(0.657 in)
Backing Colour	White	
Connector Type	200mm long (7.874 in) flat cable on both ends, stripped 10mm and tinned	

Output & Electrical (All 5-in-1 LED Tapes)

Beam Angle	120°
Operating Voltage	24VDC
Current	2.5 A
Density	60 LEDs/m
LED Chip Size	5050



Output - HiQ High CRI only

Colour(s)	RGB+WW+CW
Colour Temperature	2700 K, 6500 K
Wavelength	622/522/468 nm
Brightness	960 lumens/m
CRI	>95
Power Consumption	72 w/5m (4.39 w/ft)

Output - RGBACW only

Colour(s)	RGB+A+CW
Colour Temperature	6500K ± 500K
Wavelength	622/518/468/588
Brightness	700 lumens/m
CRI	≥80
Power Consumption	60 w/5m (3.66 w/ft)

Product Information

Use Environment	Indoor
Dimmable	Fully Dimmable
Average Life	50,000 hours
Warranty	Two years
IP Rating	IP20
Compliance	ETL, CE, RoHS   

QolorFLEX® HiQ High CRI LED Tape

3200K:	2835-24-H3200-120-5-20-1
6000K	2835-24-H6000-120-5-20-1
2700-6500K:	3527-24-H27006500-120-5-20-1

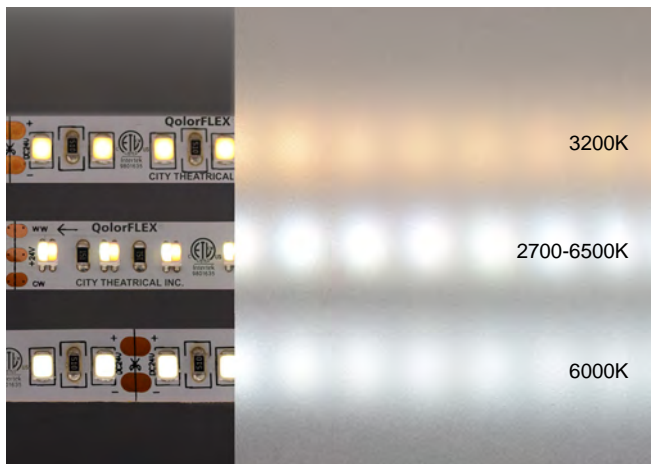

QolorFLEX HiQ High CRI LED Tapes were designed to have a Colour Rendering Index (CRI) of 95+, making them an ideal high CRI LED tape for the needs of the film industry. **QolorFLEX HiQ High CRI LED Tape** offers exceptional on-camera colour rendition and allows lighting professionals to match the light sources already being used on their set. It is available in three colour temperatures: **3200K**, **6000K**, and **2700-6500K**. Like all 40+ types of QolorFLEX LED Tape, **QolorFLEX HiQ High CRI LED Tape** is sold in 5m reels and includes six-inch long pigtailed on both ends for easy connections to QolorFLEX Dimmers for flicker-free dimming.

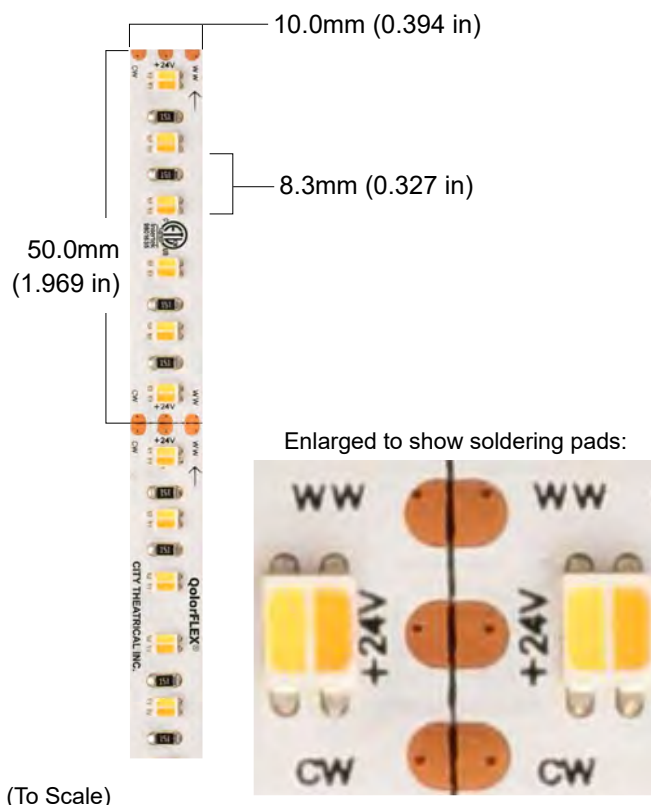

(To Scale)

SPECIFICATIONS:

Physical		
Length	5m	(16.404 ft)
Width	10mm	(0.394 in)
Cutting Increment	50mm	(1.969 in)
LED Spacing	8.3mm	(0.327 in)
Backing Colour	White	
Connector Type	200mm long (7.874 in) flat cable on both ends, stripped 10mm and tinned	

Output	
3200K Colour/Colour Temp.	Warm White; 3200K ± 200K
6000K Colour/Colour Temp.	Cool White; 6000K ± 200K
2700-6500K Colour/Colour Temperature	Warm White +Cool White; 2700K±150K, 6500K±500K
Beam Angle	120°
Brightness	1200 lumens/m
Colour Rendering Index (CRI)	≥ 95

Electrical (All HiQ High CRI LED Tapes)	
Operating Voltage	24VDC
Density	120 LEDs/m

Electrical - 3200K or 6000K only

Current	2600 mA/5m
Power Consumption	63 w/5m (3.8 w/ft)
LED Chip Size	2835

Electrical - 2700-6500K only

Current	3200 mA/5m
Power Consumption	77w/5m (4.69w/ft)
LED Chip Size	3527

Product Information

Use Environment	Indoor
Dimmable	Fully Dimmable
Average Life	50,000 hours
Warranty	Two years
IP Rating	IP20
Compliance	ETL, CE, RoHS

Tunable White HiQ High CRI:	N914-H6500 2700-5	Amber:	N914-A-10
Cool White:	N914-CW-10	Blue:	N914-B-10
Natural White:	N914-NW-10	Red:	N914-R-10
Warm White:	N914-WW-10	Green:	N914-G-10
		RGB:	N914-RGB-5

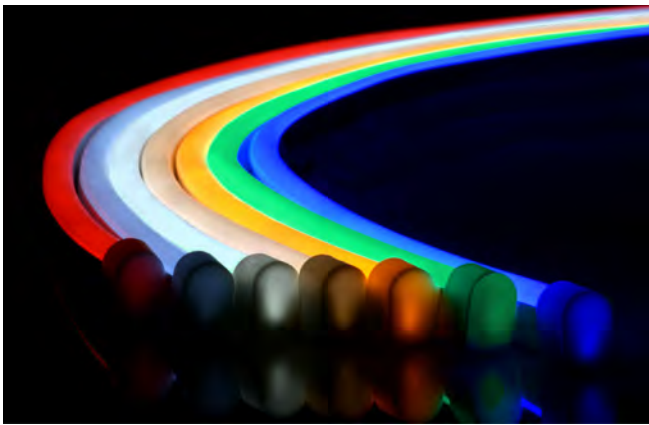

QolorFLEX NuNeon is a sealed LED linear product that is flexible and safe for indoor or outdoor use. QolorFLEX NuNeon can be cut to length and offers nearly the same visual impact as traditional blown glass neon without the problematic issue of installation and maintenance. QolorFLEX NuNeon operates on 24VDC and can be powered and controlled by a variety of QolorFLEX Dimmers and power supplies.

New **QolorFLEX NuNeon, Tunable White HiQ High CRI** (P/N N914-H27006500-5) is a sealed LED linear product that is flexible and safe for indoor or outdoor use. It offers exceptional on-camera colour rendition with a colour rendering index greater than 94, allowing lighting professionals to meet the needs of high quality film and video lighting.

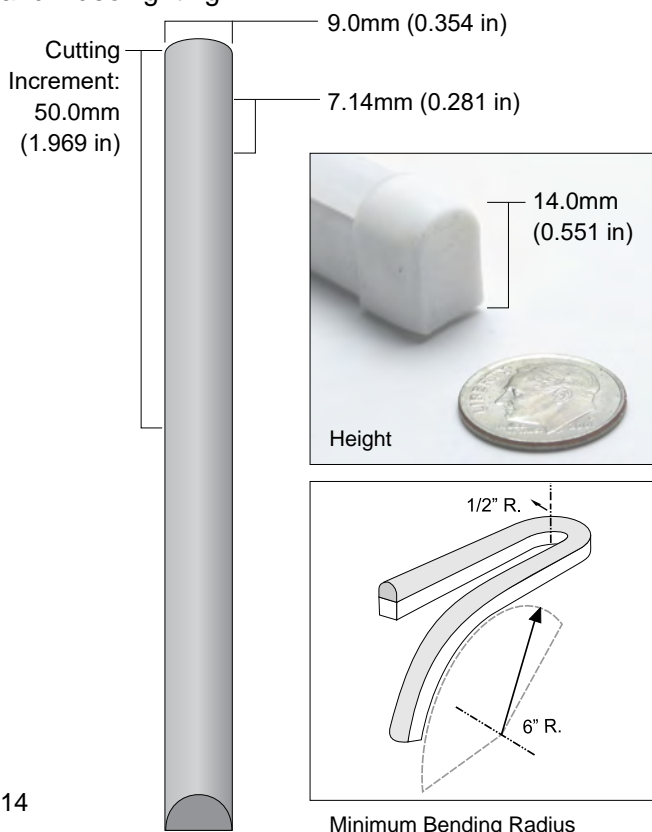

Physical

Length	5m (16.4 ft)	RGB & HiQ
	10m (32.8 ft)	All others
Height	14mm	(0.551 in)
Width	9mm	(0.354 in)
Cutting Increment	50mm	(1.969 in)
LED Spacing	7.14mm	(0.281 in)
Material	Silicone Extrusion	
Type	White Finish	
Connector Type	200mm long (7.874 in) jacketed cable on both ends, stripped 10mm and tinned	
Minimum Bending Radius	Flat plane:	1/2"
	Global axis:	6"

Output

Beam Angle	120°
Colour Temperature and Lumens per metre for:	
Tunable White HiQ High CRI:	2700 K, 6500 K / 600 lm/m
Cool White:	6500 K / 650 lm/m
Natural White:	4000 K / 750 lm/m
Warm White:	2700 K / 750 lm/m

Wavelength and Lumens per metre for:	
RGB:	622/518/468 nm / 330 lm/m
Amber:	588 nm / 150 lm/m
Blue:	468 nm / 85 lm/m
Green:	518 nm / 650 lm/m
Red:	622 nm / 200 lm/m

Electrical

Operating Voltage	24VDC
Current	2.0A (RGB); 2.9A (Tunable White HiQ); 3.0A (Single Colours)
Power Consumption	58w/5m (RGB); 70w/5m (Tunable White HiQ); 72w/10m (Single Colours)
Density	140 LEDs/m
LED Type	3528 (RGB); 2835 (Tunable White; 1 Colour)

Product Information

Use Environment	Indoor/ Outdoor
Average Life	50,000 hours
Warranty	Two years
IP Rating	IP67
Compliance	ETL, CE, RoHS

QolorFLEX® 5x2.5A Multiverse® Dimmer (P/N 5943)



QolorFLEX®
PROFESSIONAL LED LIGHTING

SPECIFICATIONS:

P/N	Frequency	Universes
5943	2.4GHz	1

Physical		
Length	10.0 cm	(3.94 in)
with Antenna	14.3 cm	(5.63 in)
Width	5.9 cm	(2.31 in)
with Phoenix Connectors	7.0 cm	(2.75 in)
Height	1.6 cm	(0.63 in)
Weight	0.07 kg	(0.15 lbs.)
Construction	NEMA 4 IP20 ABS Plastic	
Connections	Pluggable connectors	
Mounting	Plastic bracket included	

Dimming Information	
Voltage Range	5 - 30 VDC
PWM Frequencies (Hz)	60, 1.2K, 2.4K, 5K, 12K, 24K, 50K
Power	4A/channel maximum; 12.5A total
Control Resolution	6 DMX Personality options, including: 8-bit (5ch), 16-bit (10ch), 8-bit Tunable White Single (2ch), 16-bit Tunable White Single (4ch), 8-bit Tunable White (4ch), 16-bit Tunable White (8ch)
PWM Resolution	20-bit



QolorFLEX® 5x2.5A 2.4GHz Multiverse® Dimmer (P/N 5943) is a constant voltage, five-output dimmer that can be controlled wirelessly (with Multiverse Technology), or with wired DMX. This dimmer provides 20-bit PWM resolution and six DMX personality options (including: 8-bit (5ch), 16-bit (10ch), 8-bit Tunable White Single (2ch), 16-bit Tunable White Single (4ch), 8-bit Tunable White (4ch), and 16-bit Tunable White (8ch)) for extremely smooth dimming at the low end of the dimming curve. It uses detachable input and output connectors to make wiring easy. Configuration is performed using RDM, such as with a City Theatrical DMXcat®, or with City Theatrical's USB Configuration program for PC/Mac. A mounting bracket is included with the Dimmer to allow easy mounting to scenery. This dimmer is designed and built in the USA by City Theatrical. It pairs perfectly with QolorFLEX 5-in-1 LED Tape for ideal use in props and costumes, or for areas where space is a concern.

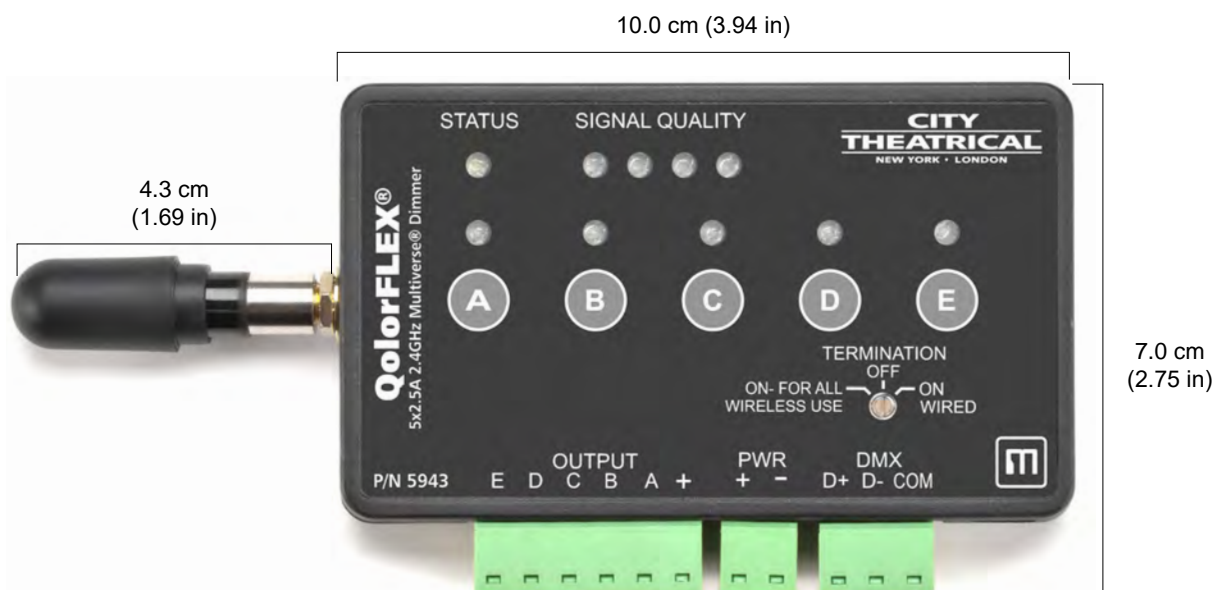

QolorFLEX® 2x2.5A Multiverse® Dimmer (P/N 5916)



QolorFLEX®
PROFESSIONAL LED LIGHTING

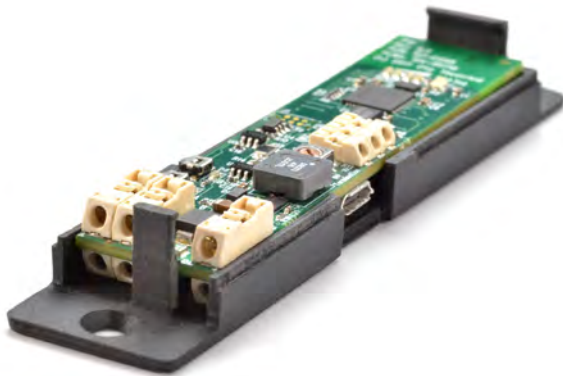

SPECIFICATIONS:

P/N	Frequency	Universes
5916	2.4GHz	1

Physical

Length (w/ plastic case)	108 mm	(4.125 in)
Board only	81 mm	(3.2 in)
Width (w/ plastic case)	22 mm	(0.875 in)
Board only	19 mm	(0.75 in)
Height	14 mm	(0.562 in)
Board only	10 mm	(0.38 in)
Weight	0.02 kg	(0.05 lbs.)
Connections	Low profile latch connectors	
Construction	NEMA 4 IP20 ABS Plastic	
Mounting	Screw holes in tabs on ends of plastic case	

Dimming Information

Input Voltage Range	5 - 30 VDC
PWM Frequencies (Hz)	60 incan, 1.2K LED, 1.2K candle, 2.4K LED, 5K LED, 12K LED, 24K LED, 50K LED
Power	4A/channel maximum; 5A total
Control Resolution	Four DMX personality options: 8-bit (5ch), 16-bit (10ch), 8-bit Tunable White Single (2ch), and 16-bit Tunable White Single (4ch)
PWM Resolution	20-bit

QolorFLEX® 2x2.5A 2.4GHz Multiverse® Dimmers are small, constant voltage, two-output dimmers designed to be mounted in small spaces such as props, costumes, wands, and candles. They can be controlled wirelessly using City Theatrical's Multiverse or SHoW DMX Neo wireless DMX/RDM technology, or with wired DMX. Each dimmer provides 20-bit PWM resolution and four DMX personality options (two variations of 8-bit and 16-bit control) for extremely smooth dimming at the low end of the dimming curve. Configuration is performed using RDM, such as with a City Theatrical DMXcat®, or with City Theatrical's USB Configuration program for PC/Mac. A plastic case is included with each QolorFLEX 2x2.5A Multiverse Dimmer to allow easy mounting to scenery while enabling removal of the dimmer from the case for wiring and configuration. These dimmers are designed and built in the USA by City Theatrical.



W:
22 mm
(0.88 in)

L: 108 mm
(4.125 in)



H:
14 mm
(0.56 in)

QolorFLEX® Dimmers

(P/Ns 5809, 5810, 5823, 5825, 5821)



QolorFLEX 5x8A Dimmers P/N 5809

QolorFLEX 5x8A Dimmers are low voltage, constant voltage, dimmers designed to operate perfectly with QolorFLEX LED tape for professional use, and can control a full 40A of LED tape spread 8A each. This allows the control of unique combinations of LED tape, such as QolorFLEX 5-in-1 LED Tape (five channels), RGBX tape (four channels), RGB tape (three channels), bi-colour tape (two channels), and/or a single colour tape (one channel) together in one unit. DMX/RDM control or stand alone mode. For indoor use. Requires an external power supply to suit the LED tape you are using.



QolorFLEX 24x3A Dimmers P/N 5810

QolorFLEX 24x3A Dimmers are low voltage, constant voltage, dimmers ideal for applications such as retail displays, signage, and general architectural work. They feature 24 channels of control and are ideal for 1, 2, 3 or 4 colour LED tape installations. This dimmer is fully DMX and RDM compatible and offers stand alone functions. The maximum current load per channel is 3A with maximum device output of 72A. Requires an external power supply to suit the LED tape you are using. For indoor use.



QolorFLEX 4x5A DINrail RJ45 Dimmers P/N 5823

QolorFLEX 4x5A DINrail RJ45 Dimmers are low voltage, constant voltage, dimmers and can control a full 20A of LED tape spread over four channels of 5A each. The unit mounts to a standard hat section DINrail, and features two RJ45 connectors for DMX communication. Requires an external power supply to suit the LED tape you are using. For indoor use.



QolorFLEX 4x5A DINrail Dimmers P/N 5825

QolorFLEX 4x5A DINrail Dimmers are low voltage, constant voltage, dimmers and can control a full 20A of LED tape spread over four channels of 5A each. The unit mounts to a standard hat section DINrail, and has terminal blocks for all electrical and DMX connections. Requires an external power supply to suit the LED tape you are using. For indoor use.



QolorFLEX 4x5A Dimmers P/N 5821

QolorFLEX 4x5A Dimmers are low voltage, constant voltage dimmers, and can control a full 20A of LED tape spread over four channels of 5A each. The unit is easily surface mounted and has spring contact terminal blocks for all electrical and DMX connections. Requires an external power supply to suit the LED tape you are using. For indoor use.



Beam Control

Beam Control Accessories: Achieve Your Vision

Since our inception over 35 years ago, City Theatrical has worked with lighting professionals to invent, manufacture, and customise high quality lighting accessories. Our mission is to create products that enable lighting professionals to achieve their artistic vision. Even a single lighting accessory, like Blacktak™ Light Mask Foil, Barndoors, Track Tamers™, or custom beam shapers, can help you make your next film project even better.



Blacktak Light Mask Foil



ColorForce Barndoors

Barndoors

City Theatrical's Barndoors have aluminium leaves for light weight and durability, and nylock nuts to enable the tension of the doors to be adjusted if wear occurs over time. Many have round frames that allow the doors to rotate to the optimum position. City Theatrical Barndoors also include those designed to fit ETC fos/4 light fixtures.

P/N Barndoors for ETC fos/4 fixtures

2600	ETC fos/4 Panel Barndoor, P8
2602	ETC fos/4 Panel Barndoor, P16
2604	ETC fos/4 Panel Barndoor, P24 <i>(shown below, left)</i>
2632	ETC fos/4 Fresnel 7 Barndoor <i>(shown below, right)</i>

Track Tamers

Load-rated Track Tamers separate the lockdown of the track from the lockdown of the lighting fixture, making the lighting technician's job faster and safer. Many lighting installations use Unistrut with Unistrut nuts, but Unistrut nuts are not designed to hang and focus lighting fixtures. Once loosened, a Unistrut nut can pop out of the track and leave you with a lighting fixture in your arms at the top of a lift or ladder.

City Theatrical Track Tamers' deep grooves grip the track tightly to prevent it from coming out, and separate the lockdown of the track from the lockdown of the lighting fixture. Track Tamers allow you to safely and quickly hang, slide to position, focus, and tightly lock a lighting fixture with no danger of it falling out of the track.



City Theatrical Barndoors providing beam control for ETC fos/4 panel and fresnel lighting fixtures

Custom Beam Shapers

Need a beam control accessory for a moving light, ellipsoidal, LED PAR, or other lighting fixture? Our full line catalogue may have it, but if not, our skilled metalworkers can quickly make it for you custom.



Track Tamers

Contact

Matt Stearnes
European Customer Services
City Theatrical Ltd.
mstearnes@citytheatrical.com

www.citytheatrical.com

+44 (0) 20 8949 5051

Multiverse® Transmitter
900 MHz/2.4GHz

P/N 5910

**CITY
THEATRICAL**
NEW YORK · LONDON

City Theatrical Ltd. Office: Office 31, Units 1-3
Beverley Way | New Malden, KT3 4PH, U.K.